

# Basswood & Fauxwood Blind Installation Instructions

## Please follow these Installation Instructions

You will need a pencil, tape measure, drill, screwdriver, pliers, and appropriate fasteners.

### Step 1: Choose the Correct Fastener

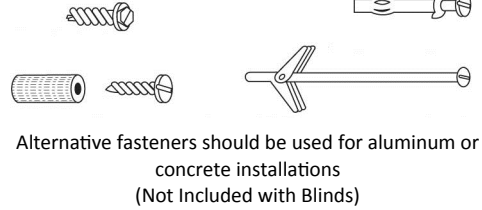
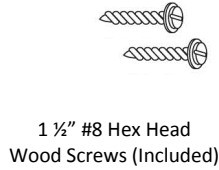

### Step 2: Prepare Brackets

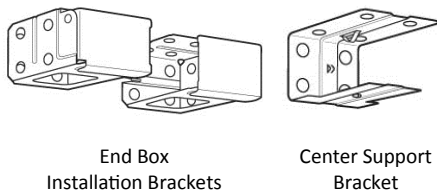

Use the following # of Center Support Installation Brackets based on the Blind Width:		
Up to 49"	49 1/8" - 72 7/8"	73" and Greater
0	1	2

### Prepare box brackets for installation:

Open the front of the bracket by pressing on the bottom of the bracket to release the locking tab while lifting the front gate.

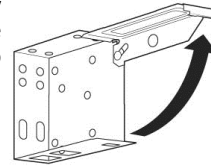

### Step 3: Mark the Bracket Locations

*(For Outside Mount Installations)*

Position the box brackets at each end of the headrail. When using a single center support bracket, center it between the box brackets. For more than one center support bracket, space the support brackets evenly, not more than 30" apart. Make sure the brackets will not interfere with the cord mechanism or any other internal parts. Mark the bracket for mounting hole locations, making sure they are square and equally spaced. For outside mount installations, use a level to check for levelness.

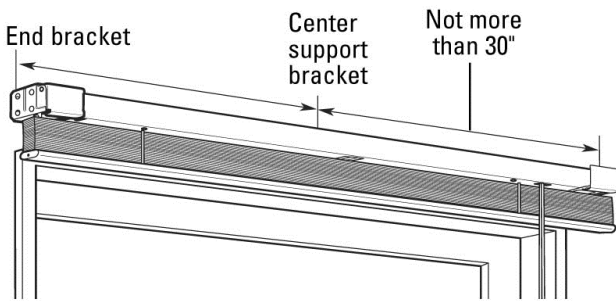

*(For Inside Mount Installations)*

Position the box brackets at each end of the headrail. Depending on the installation location, box brackets can be attached using the top, back, or side holes. When using a single center support bracket, center it between the box brackets. For more than one center support bracket, space the support brackets evenly, not more than 30" apart. Make sure the brackets will not interfere with the cord mechanism or any other parts. Mark the location of the desired bracket mounting holes, making sure that they are square and equally spaced.

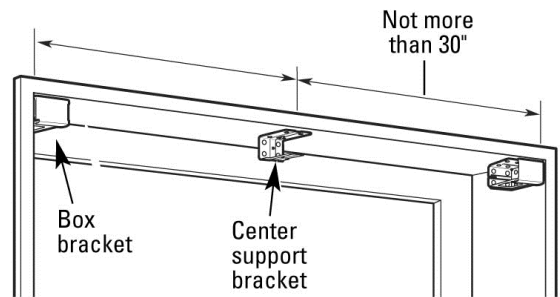

### Step 4: Bracket Installation

*(For Outside Mount Installations)*

Screw brackets into wall as shown.

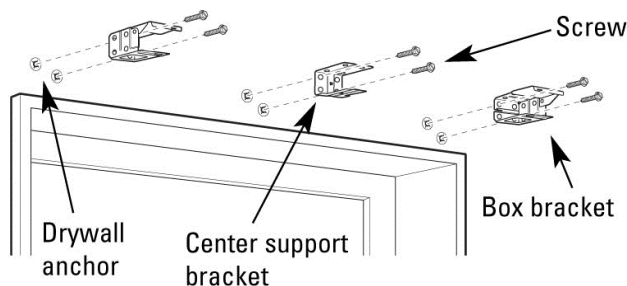

*(For Inside Mount Installations)*

Screw brackets in window frame as shown.

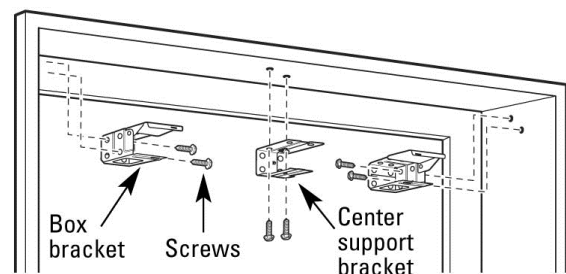

# Basswood & Fauxwood Blind Installation Instructions

## Step 5: Valance Installation— with clip

**Step 1.** Slide Metal Valance Clip into the “T” groove on the back of the valance. Twist the valance clip to lineup the top of the clip with the top of the valance. Repeat this step for all clips provided.

**Step 2.** Place the valance with clips attached over the headrail and press it down to until they snap into the headrail.

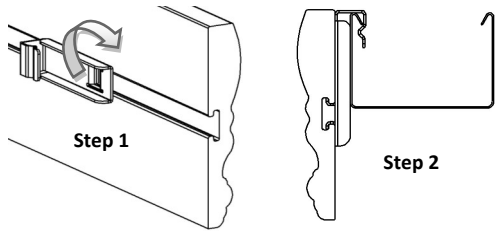

## Valance Installation— with magnets

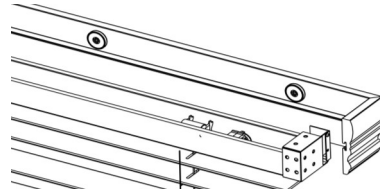

**Step 1.** To install valance with magnets apply the valance to front of the headrail. Make sure the valance is level.

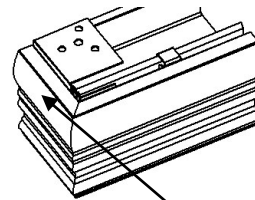

Valance shown with the side return

### Valance Clips Needed

Up to 47.99"	48" - 71.99"	72" - 95.99"	96" - 119.99"	120" +
2	3	4	5	6

For your convenience , extra valance clips are included.

## Step 6: Blind Installation

Align the headrail with the center support and box brackets. The headrail should have the tilt mechanism facing toward the room. Be careful not to trap the top slat in the brackets and slide the headrail straight back until it is snug in the brackets. If the headrail can slide from side to side in the box brackets, you can use a flat head screwdriver to bend out the tabs on the end of the until it is snug.

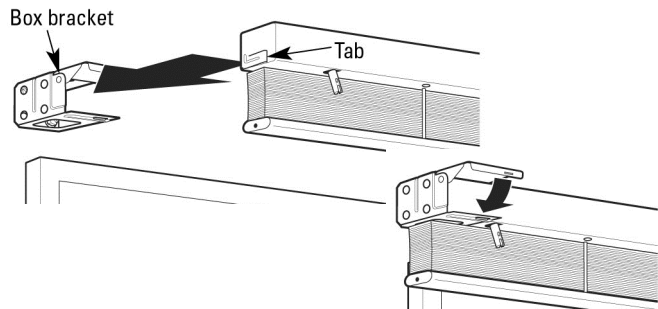

## Step 7: Safety Cleat Installation

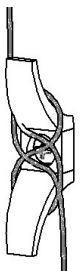

Find a convenient place about 1" out from the side of the shade where the pull cords are located and about one quarter of the way up from the bottom of the shade. Hold the cord safety cleat parallel with the window frame. With a pencil, make a mark through the holes. Screw the cord safety clip to the wall.

To avoid strangulation and entanglement keep all cords out of reach of children by installing safety cleats that limit access to the cord and /or chain.

## Step 8: Attach Hold Down Brackets (Optional—Typically used for door installations)

With the hold-down brackets attached to the bottom rail, lower the blind to the hold down bracket mounting surface and mark the bracket locations. Attach the hold down brackets at the bottom of the window or door with the included screws as shown. To attach the bottomrail, gently pull the brackets out slightly, and insert the pins into the holes on the bottomrail of the blinds.

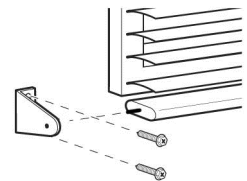

## Operating Instructions:

**To lower the blind,** pull the cord down and towards the center of the shade to unlock the cord. Then, slowly release the cord until the shade reaches the desired location. Move the cord past the outer edge of the shade and let go to lock the cord.

**To raise the blind,** pull the cord straight down until the shade reaches the desired location. Move the cord past the outer edge of the shade and let go to lock the cord.